



***POWER SPORTS***

OWNER'S MANUAL

**2400.1**

EVOP*PS*

Introduction .....	3
Features .....	3
Package contents .....	3
Safety instructions .....	4
<b>Technologies</b>	
DTM® .....	5
Ultra Compact PCB .....	5
Robust Construction .....	5
I-Power Supply .....	5
Full Range .....	6
Marinization with protection index Ip64 .....	6
Assembling and Disassembling the Plastic Seals .....	7
<b>Panels description</b>	
Audio inputs and controls.....	8
Power inputs and audio outputs .....	9
Electrical Dimensioning.....	9
Installation sequence.....	10
<b>Wiring diagram</b>	
Wiring diagram.....	11
Procedure for setting the gain.....	12
Crossovers set up.....	13
<b>Technical specs</b>	
Parameters.....	14
Dimensional data.....	14

## DEAR CUSTOMER,

### CONGRATULATIONS ON ACQUIRING A PRODUCT WITH THE HIGHEST QUALITY AND TECHNOLOGY!

You have just purchased a **SoundDigital** product of the highest technology and quality, so we thank you for your confidence.

**SoundDigital** products are made with raw materials of the highest quality standards, and the most modern processes, equipment and technology are used in their production.

On this manual you will learn about the product, its features and characteristics, in order to obtain the best result and to be able to enjoy your music with **SoundDigital** quality and power.

To better understand and take advantage of all the functions of the product and use it safely, read this manual carefully and if you have any questions, consult our support by email **info@sounddigitalusa.com**.

## FEATURES

- Resistant to moisture, water splash and dust;
- Compact design;
- Conformal coated PCB;
- Variable crossover with LP, FULL and HP selector switch;
- High efficiency Class D;
- Robust construction, resistant to vibrations and bumps;
- IP64 Rating.

## PACKAGE CONTENTS

- 01 **2400.1 EVOPS** Amplifier
- 01 Installation quick guide with warranty card
- 01 Allen wrench 2.0mm
- 01 Allen wrench 2.5mm
- 01 Allen wrench 3.0mm
- 01 Promotional sticker

To prevent injuries to the user or damage to the amplifier, read all safety instructions written on this manual;

If you are insecure about the installation of this equipment, get in touch with our tech support or with a professional specialized in car audio/vessel audio installation;

Before proceeding with the installation of any electric equipment on your vehicle/vessel, unplug the negative (-) terminal of the battery to avoid fires, injuries or damages;

Use your sound system safely. The continuous exposure to sound pressures over 85dB may cause irreversible hearing damage;

This equipment is for use in DC voltage batteries between 12.6 and 14.4 volts. Before installing the equipment, check voltage of the batteries;

Choose a ventilated place to install the amplifier;

Mount the amplifier in a secure way. Avoid mounting it on metallic parts of the vehicle/vessel, because it may cause ground looping (noise);

Make sure that the location chosen for the amplifier installation does not effect the operation of the vehicle/vessel;

Please select a dry location to mount your amplifier. The products are designed to operate in humid environments but the direct contact with water can damage the amplifier;

When passing cables through metallic walls, use rubber O-rings to avoid cable cutting and short-circuits;

Clean the amplifier periodically with brush or dry cloth to assure the thermal efficiency of the heatsink;

This product may reach temperatures over 60°C/140°F. Make sure it is cold before touching it;

Be careful when making holes in the vehicle/vessel. Make sure you are not making holes in the fuel tank, brake lines, boat hull or electrical cables of the vehicle/vessel;

Make sure the cables are properly secured throughout the installation;

Wear gloves, safety glasses and and all necessary PPE during the installation of SounDigital amplifiers.



**Warning!**

**THIS "WARNING" SIGN ALERTS THE USER OF IMPORTANT INFO. NOT FOLLOWING THIS INSTRUCTIONS MAY CAUSE INJURIES TO THE USER OR DAMAGE TO THE EQUIPMENT.**

## DYNAMIC THERMAL MANAGEMENT - DTM®

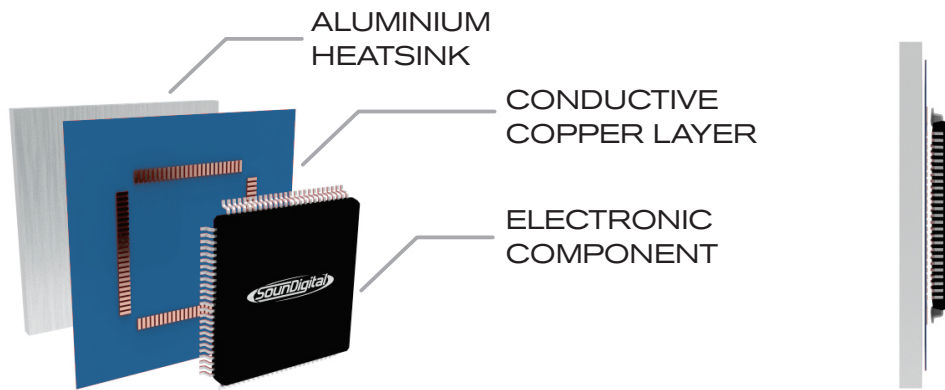

The **DTM\*** is a dynamic thermal recovery system which always maintains a high efficiency of the amplifier by accelerating the thermal exchange of electronic components with the heatsink.

\* Patent. Required

## ULTRA COMPACT PCB

An intelligent layout, with great use of the PCB area and the use of modern components with reduced structure guarantee **SounDigital** products a compact design, at the same time robust and with excellent thermal efficiency.

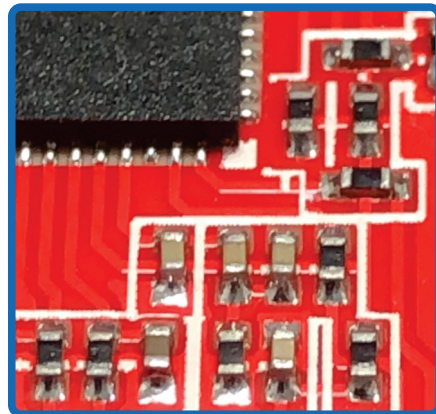

## ROBUST CONSTRUCTION

Thinking about the application of power sports, the product has an extremely robust assembly, both the fixing points and the layout of the PCB were designed to withstand high vibrations, bumps and impacts.

## I - POWER SUPPLY

SounDigital amplifiers are known for their low consumption of battery, and this feature was improved on the **EVOPS Line**. The new **I-POWER SUPPLY** is even more modern, which replaces the old toroidal transformers by a new generation of "E-E" core transformers delivers efficiency above 90% \*, ensuring more hours of sound without battery recharge.

\*Efficiency measured at power supply only



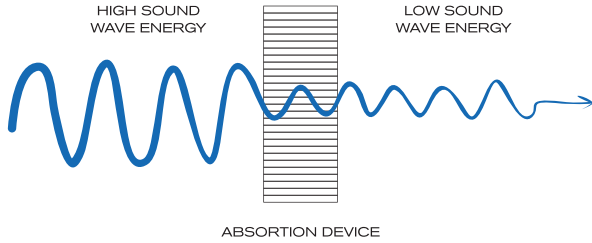

**VIBRATION ABSORPTION DEVICE - VAD®**

Our VAD® Technology reduces all impact caused by vibration on the electronic circuit board. This can include road vibration and even vibration caused by sound waves, increasing the reliability of our amplifiers.

**REDUCED SIZE**

The technology used in our amplifiers bring both high performance and power a compact chassis, providing flexible installation solutions for vehicles with limited space.

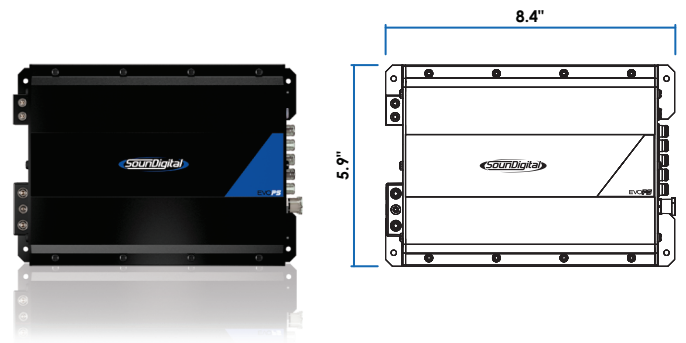

**FULL RANGE**

Versatile products that cover the entire audible frequency range, any type of loudspeaker or music program.

**MARINIZATION WITH PROTECTION INDEX IP64**

The product is protected against ingress of dust particles and water droplets from all sides, beyond that, the PCB receives a conformal coating treatment to protect the components from moisture.

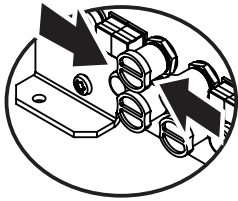
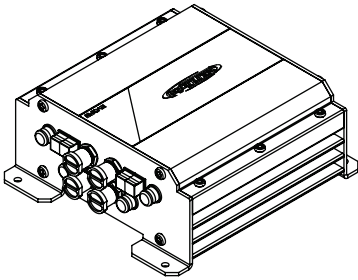
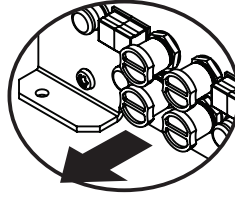
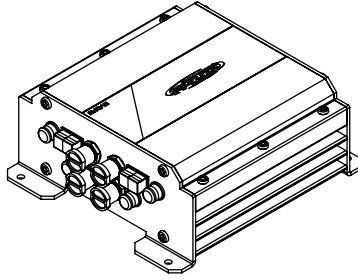
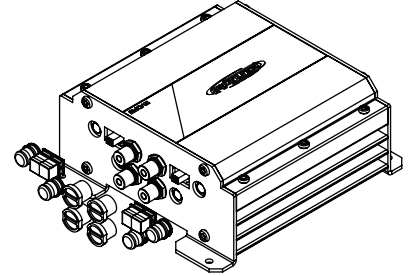

**DISASSEMBLING THE PLASTICS SEALS****1****2****3**

- 1.** Squeeze the assembled Flexible Plastics Seals
- 2.** Pull out the Plastics Seals

\*Merely illustrative images.

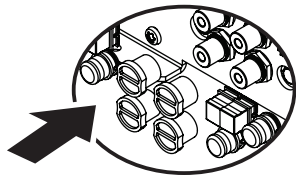
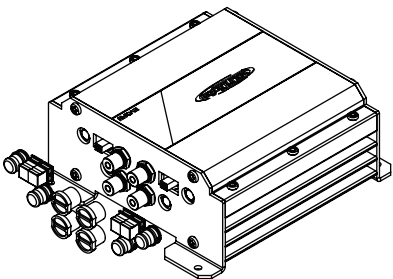
**ASSEMBLING THE PLASTICS SEALS****1****2**

**RCA  
Plastic Seal**



**Potentiometer  
Plastic Seal**

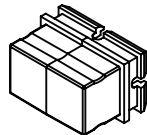

**Slide switch  
Plastic Seal**

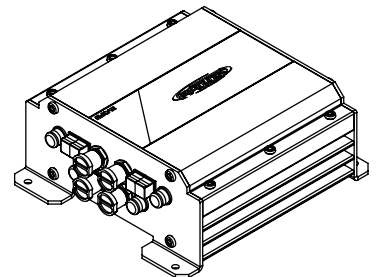
**3**

- 1.** Hold the disassembled Flexible Plastics Seals and fit them in their specific housing;
- 2.** Each connector has its specific Plastic Seal;
- 3.** Make sure the Flexible Plastics Seals are perfectly fitted.

\*Merely illustrative images.

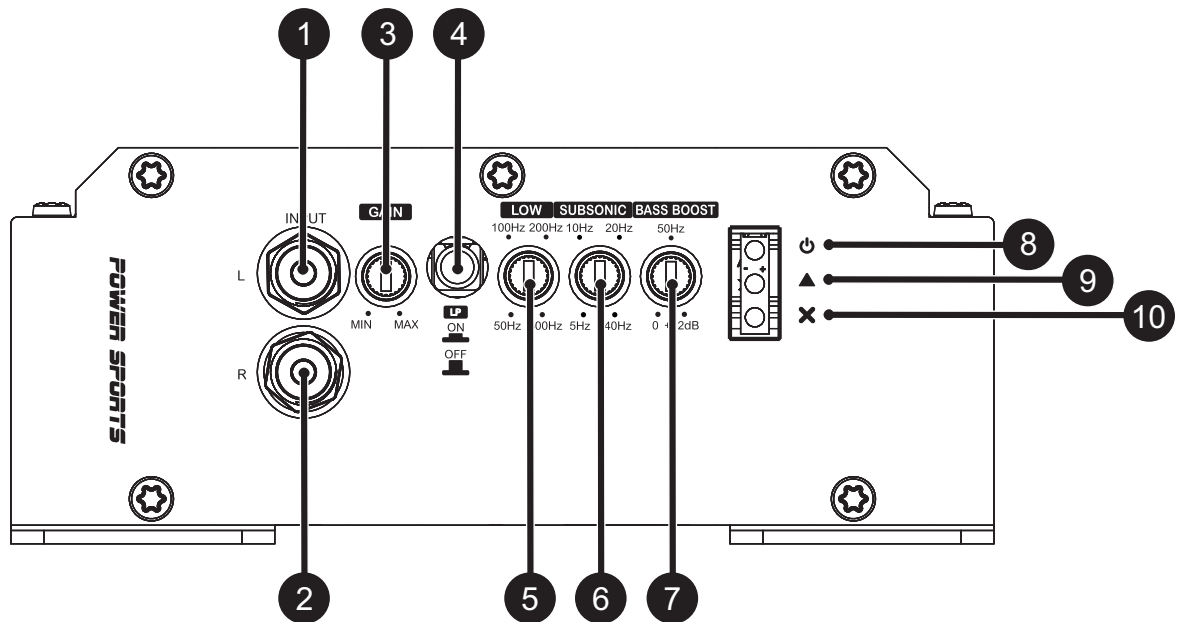

1	Left Channel	Audio inputs - RCA connectors
2	Right Channel	
3	-	Variable Gain control
4	-	Low Pass filter ON/OFF switch key
5	-	Variable Low Pass filter control (50Hz ~ 500Hz)
6	-	Variable Subsonic filter control (5Hz ~ 40Hz)
7	-	Variable Bass Boost Control 50Hz (0dB ~ +12dB)
8	Blue	"Power ON" LED indicator
9	Yellow	"Clip" LED indicator
10	Red	"Protection" LED indicator



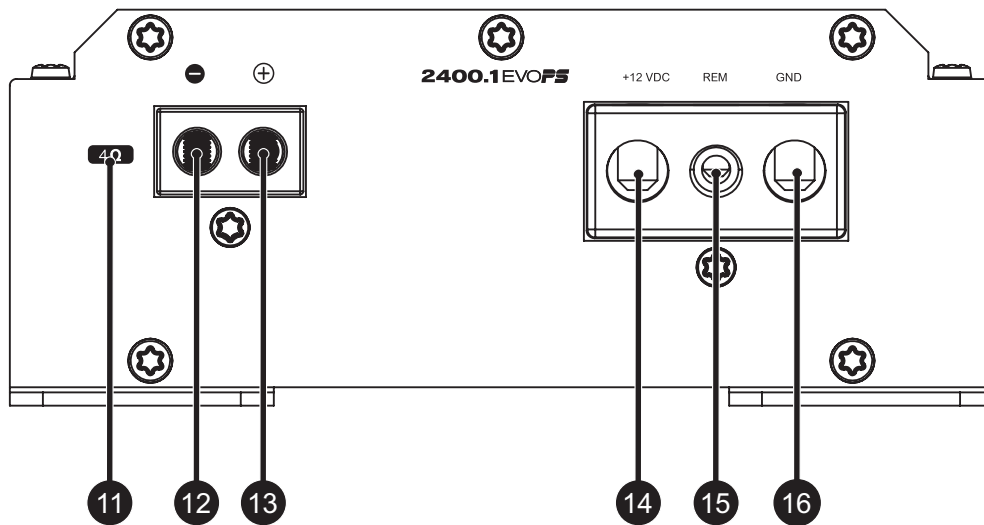

11	-	Minimum speaker load allowed (impedance) 2Ω or 4Ω
12	-	Negative speaker connector
13	-	Positive speaker connector
14	-	Positive power supply connector (+12VDC)
15	-	Remote power supply connector (REM)
16	-	Negative power supply connector (GND)

## ELECTRICAL DIMENSIONING

For proper operation of your SoundDigital amplifier, you need the proper dimensioning of the electrical system and the cables used.

The table below shows the minimum section of GND cables, +12VDC cables and speaker output cables according to the power generated by the amplifier.

2400 WRMS	POWER CABLE	21mm <sup>2</sup> - 4 AWG
	GROUND CABLE	21mm <sup>2</sup> - 4 AWG
	SPEAKER CABLE	<p><b>2400.1 EVOFS 2Ω</b> 2 x 4,0mm<sup>2</sup> - 11 AWG</p> <p><b>2400.1 EVOFS 4Ω</b> 2 x 2,5mm<sup>2</sup> - 13 AWG</p>

We recommend the use of ONLY OFC (Oxygen Free Copper) Cables on the installation of our products.

**Warning!**

BEFORE PROCEEDING WITH THE INSTALLATION, UNPLUG THE NEGATIVE TERMINAL FROM ALL OF THE BATTERIES, TO AVOID FIRE, DAMAGE TO THE AMPLIFIER AND THE USER HIMSELF.

- Mount the amplifier in such a way you have access to the connectors;
- Install the power cables in the vehicle/vessel properly, starting from the battery to the fuse holder or circuit breaker, use the cable with the appropriate size. Make all connections, install fuse holders or circuit breakers, but without placing the fuses or with the circuit breakers in the "OFF" position;

**Warning!**

➤ THE MAX: DISTANCE FOR THE INSTALLATION OF THE FUSE/CIRCUIT BREAKER IS 12 INCHES (30 CM) AWAY FROM THE BATTERY.

- Connect the power cables in to the amplifier, observing the polarity. Connect all the positive cables from the fuse holder or circuit breaker to the positive connector of the amplifier and all the negative power cables from the batteries to the negative connector of the amplifier;
- The ground cable must be as short as possible and must be connected to the negative connector of battery or vehicle chassis in case of metallic chassis;

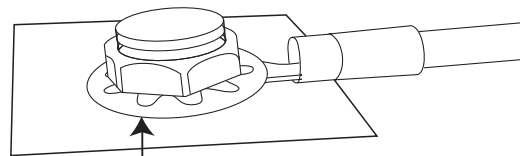

Remove the paint between the terminal and chassis

- Install the signal input cables in a proper way, distant from the power cables;
- Connect the RCA or the High level signal input cables to the head unit and amplifiers;
- Install the audio output cables with the appropriate section, distant from the power and audio input cables;
- Connect the audio output cables to the amplifier and speakers respecting the positive (+) and negative (-) polarities;
- Install the remote cable with the power cables, using 1.5mm<sup>2</sup> (15 AWG) cable or thicker;
- Connect the remote power cable to the amplifier's "REM" terminal at the main unit's remote power output (when not using the high level signal inputs);
- Before powering the system, verify all the connections and make sure there are no mistakes or short-circuits on the power and ground cables;
- Reconnect the ground of the batteries;
- Check if the head unit is turned off and then place the fuses in the fuse holders or switch the circuit breakers on;
- Turn on the main unit and the amplifier will turn on the "ON" LED indicating that it is in operation.

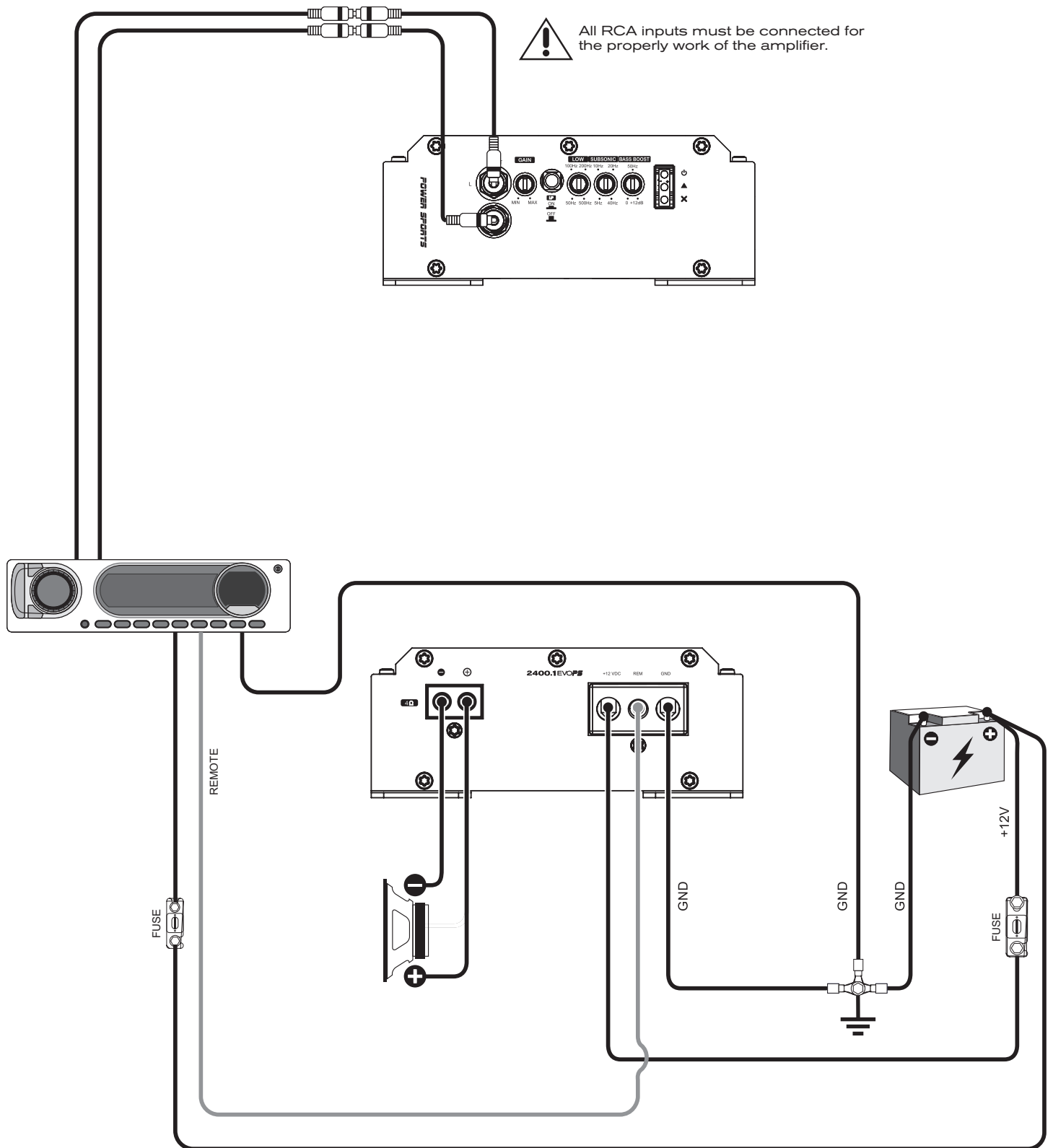

Model	Minimum Impedance
2400.1 EVOPS 2Ω	2Ω
2400.1 EVOPS 4Ω	4Ω

## GAIN SETTING

### Necessary equipment:

- Digital AC voltmeter;
- Media with sine wave test tone 60Hz recorded at 0db;
- Screwdriver 1/8" ( for gain set).

### Set up procedure

- This procedure is the same for both gain controls;
- Turn the gain control all the way down.
- Disconnect the output cables from the amplifier outputs;
- Turn off all processing (bass, treble, loudness, EQ, etc.);
- Set the source unit volume to 3/4 of full volume.
- On the CD player, adjust the audio positioning controls in the center (left and right fader controls);
- Set the Low Pass switch to "OFF";
- Use a 60 Hz sine wave;
- Connect the AC voltmeter to the speaker output connectors of the amplifier. Make sure you test the voltage at the correct connectors (+ and -);
- Increase the gain control until the target voltage is observed with the voltmeter (see the chart below);
- Once you have adjusted the amplifier to its correct voltage output, turn off the source unit and reconnect the speaker(s)

Download the tracks for set up in <https://soundigitalusa.com/tracks-for-set-up/>

MODEL	BRIDGE / POWER	BRIDGE OUTPUT VOLTAGE
2400.1 EVOFS 2Ω	2Ω/ 2400W	69.3 V
2400.1 EVOFS 4Ω	4Ω/ 2400W	97.8 V

## Using Bass Boost

The Amplifier Bass Boost setting enables the user to boost the sound intensity at low frequencies of the sound system, where boost intensity can be adjusted.

This is a semi-parametric equalizer type circuit with "Q" value for the fixed filter, with an intensity boost adjustment from 0 to +12dB (16 times), and a central frequency adjustment of the filter in 50Hz, making it versatile for several types of sound systems.

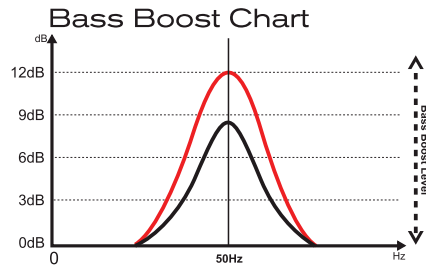

## How to Adjust Bass Boost

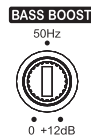

Reproduce your favorite song and set the boost intensity between 0dB and +12dB at the variable control level according your preference.

## How to Adjust the Crossovers

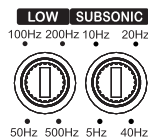

Set in the "SUBSONIC" variable control between 5Hz and 40Hz ("A") where you want to perform the subsonic cut filter;

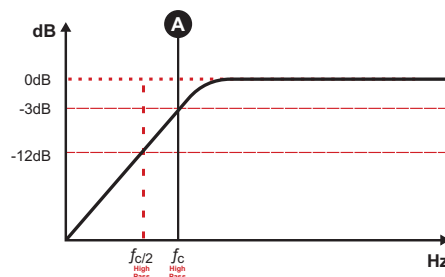

Set in the "LOW" variable control between 50Hz and 500Hz ("B") where you want to perform the low pass cut filter;

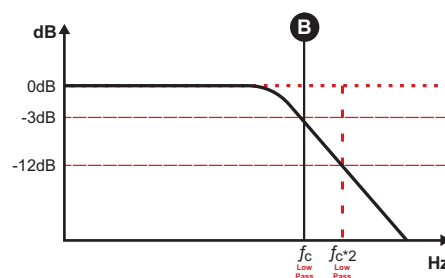

PARAMETERS	2400.1 EVOFS 2Ω	2400.1 EVOFS 4Ω
RMS Power @ 4Ω**	1584W	2400W
RMS Power @ 2Ω**	2400W	N/A
Frequency response	5Hz ~ 25kHz	5Hz ~ 25kHz
Subsonic	5Hz ~ 40Hz	5Hz ~ 40Hz
Low pass filter	50Hz ~ 500Hz	50Hz ~ 500Hz
Bass boost	0dB ~ 12dB @ 50Hz	0dB ~ 12dB @ 50Hz
Operating voltage	8V ~ 16V	8V ~ 16V
SNR	90dB	90dB
Input sensitivity	0.2V ~ 2V	0.2V ~ 2V
Current draw (music)	93A	93A
Current draw (max.)	185A	185A
Total efficiency	89%	89%
Damping factor	>2000	>2000
Power Cable	21mm <sup>2</sup> (4 AWG)	21mm <sup>2</sup> (4 AWG)
Audio Output Cable	2 x 4.0 mm <sup>2</sup> (11 AWG)	2 x 2.5 mm <sup>2</sup> (13 AWG)
Fuse* (music)	100A	100A
Recommended battery (minimum)	100Ah	100Ah

\*It is mandatory to install the fuse at a maximum distance of 12 inches from the battery.

\*\*Power at 14.4V DC @ 60Hz THD < 1%.



**\*\*REAL POWER NUMBERS  
CTA-2006 INDUSTRY STANDARDS**

## DIMENSIONAL DATA

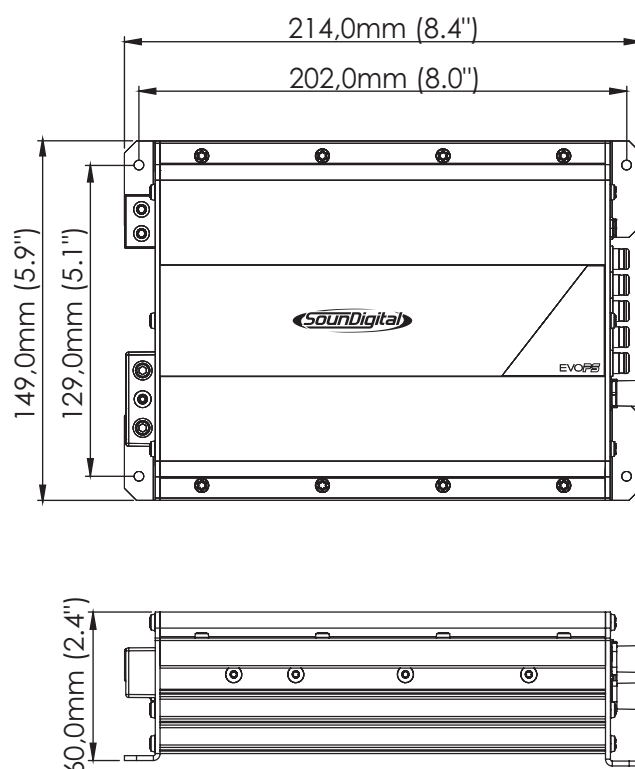



**POWER SPORTS**

# EVO<sup>PS</sup>

CODE.: 1000750309-002/JUN/2022



Consumer  
Technology  
Association™



[WWW.SOUNDIGITALUSA.COM](http://WWW.SOUNDIGITALUSA.COM)



[SOUNDIGITALUSA](https://www.facebook.com/SOUNDIGITALUSA)



[SOUNDIGITALUSA](https://www.instagram.com/SOUNDIGITALUSA)